

2/2-way Solenoid Valve with servo diaphragm

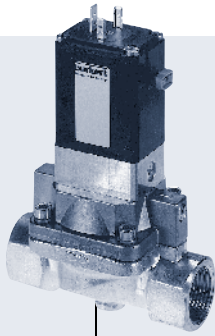

Type 5282 can be combined with...

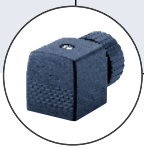

Type 2508
Cable plug



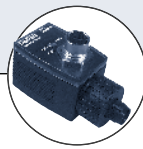

Type 1078
Timer unit



Type 2511
ASI cable plug



Type 8600
Dosing control

- Pivoted armature pilot drive with emergency manual operation
- Media separated
- Circuit function can be modified
- Adjustable switching times (waterhammer-free)
- Threaded port or flange connections
- Approvals:     

The Type 5282 is a pilot-controlled normally closed solenoid valve with a servo-diaphragm, media separated, for universal use with liquid and gaseous media corresponding to the material resistance. As standard, the 3-way pivoted armature pilot drive has an emergency manual operation. The closing and opening times are continuously adjustable.

Power consumption		
Inrush	Hold	
AC [VA]	AC [VA/W]	DC [W]
24	14/8	8

A differential pressure of 7 PSI (0.5 bar) is required to open the full orifice. The response times can be changed by turning the restrictor screws (in the body cover).

Technical data	
Orifice	1/2" - 2" (DN 13 - 65 mm)
Body material	Threaded port Flange
	Brass, stainless steel 1.4581 Stainless steel 1.4541
Seal material	NBR, FKM, EPDM (on request)
Media	NBR EPDM FKM
	Neutral media, such as compressed air, water, hydraulic oil Oil and fat-free media, incl. alkalis, hot water Hot air, oxygen, per-solutions, hot oil
Media temperature	NBR EPDM FKM
	14°F to 194°F (-10°C to +90°C) -22°F to 194°F (-30°C to +90°C) 32°F to 194°F (0°C to +90°C)
Ambient temperature	Max. 131°F (+55°C)
Voltage tolerance	±10%
Duty cycle	100% continuous rating
Electrical connection	Tag connector acc. DIN 43650 Form A for cable plug Type 2508
Protection class	IP 65 with cable plug
Installation	As required, preferably with actuator upright

* See our HazEx™ guide for ATEX and for FM Class 1, Div. 1 versions

Solenoid valve dimensions

Dimensions [mm]								
Threaded port						Flange port		
DN	D	B1	E1	F	L1	B2	G	L2
13	NPT 1/2	123.0	40	14	65	-	-	-
20	NPT 3/4	131.0	60	16	100	-	-	-
25	NPT 1	141.0	70	18	115	184.5	120	160
32	NPT 1 1/4	147.0	85	20	126	192.0	140	180
40	NPT 1 1/2	156.0	85	22	126	201.0	150	200
50	NPT 2	177.5	115	24	164	225.0	165	230
65	NPT 2 1/2	185.0	115	27	180	-	-	-

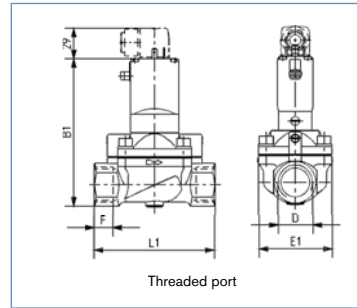

Threaded port

Ordering chart for valves (other versions on request) UL recognized / CSA/ CE
Manual override, supplied without cable plug, different seal materials on request

Circuit function	Orifice [mm]	Port connection [NPT]	Cv value water [GPM]	Nominal pressure [psi]	Voltage/frequency [V/Hz]	Item no. Seal material NBR Seal Brass Body	Item no. Seal material FKM Seal Stainless Steel Body
A 2/2-way valve, NC 	13.0 (Brass) 20.0 (Stainless steel)	NPT 1/2	4.7	2.8 - 145	024/DC	456 890	456 914
					024/50-60	456 891	456 915
					120/50-60	456 892	456 916
					240/50-60	456 893	456 917
or B 2/2-way valve, NO 	20.0	NPT 3/4	5.8	2.8 - 145	024/DC	456 894	456 918
					024/50-60	456 895	456 919
					120/50-60	456 896	456 920
					240/50-60	456 897	456 921
	25.0	NPT 1	11.7	2.8 - 145	024/DC	456 898	456 922
					024/50-60	456 899	456 923
					120/50-60	456 900	456 924
					240/50-60	456 901	456 925
	32.0	NPT 1 1/4	23.5	2.8 - 145	024/DC	456 902	456 926
					024/50-60	456 903	456 927
					120/50-60	456 904	456 928
					240/50-60	456 905	456 929
	40.0	NPT 1 1/2	23.5	2.8 - 145	024/DC	456 906	456 930
					024/50-60	456 907	456 931
					120/50-60	456 908	56 932
					240/50-60	456 909	456 933
50.0	NPT 2	47.0	2.8 - 145	024/DC	456 910	456 934	
				024/50-60	456 911	456 935	
				120/50-60	456 912	456 936	
				240/50-60	456 913	456 937	

Delivered as circuit function A
Change to the circuit function B by turning the pilot drive through 180°

Mounting instructions:

Arrangement of the pilot control

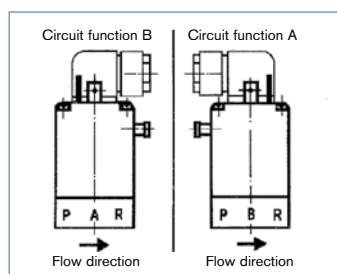

Solenoid valve ordering chart

Ordering chart for valves (other versions on request) UL listed / FM class / Division 2 / CSA / CE
 Manual override, supplied with cable plug type 2509, different seal materials on request

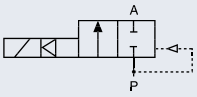
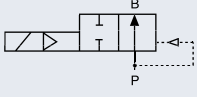
Circuit function	Orifice [mm]	Port connection [NPT]	Cv value water [GPM]	Pressure range [psi]	Voltage/frequency [V/Hz]	Item no. Threaded port NBR Brass	Item no. Threaded port FKM Stainless Steel
A 2/2-way valve NC 	13.0 (Brass)	NPT 1/2	4.7	2.8 - 145	024/DC	457 870	457 894
	20.0 (Stainless steel)				024/50-60	457 871	457 895
					120/50-60	457 872	457 896
					240/50-60	457 873	457 897
or B 2/2-way valve NO 	20.0	NPT 3/4	5.8	2.8 - 145	024/DC	457 874	457 898
	25.0				024/50-60	457 875	457 899
					120/50-60	457 876	457 900
					240/50-60	457 877	457 901
32.0	NPT 1	11.7	2.8 - 145	024/DC	457 878	457 902	
				024/50-60	457 879	457 903	
				120/50-60	457 880	457 904	
				240/50-60	457 881	457 905	
40.0	NPT 1 1/4	23.5	2.8 - 145	024/DC	457 882	457 906	
				024/50-60	457 883	457 907	
				120/50-60	457 884	457 908	
				240/50-60	457 885	457 909	
50.0	NPT 1 1/2	23.5	2.8 - 145	024/DC	457 886	457 910	
				024/50-60	457 887	457 911	
				120/50-60	457 888	457 912	
				240/50-60	457 889	457 913	
50.0	NPT 2	47.0	2.8 - 145	024/DC	457 890	457 914	
				024/50-60	457 891	457 915	
				120/50-60	457 892	457 916	
				240/50-60	457 893	457 917	

Delivered as circuit function A

Change to circuit function B by turning the pilot drive through 180°.

NOTE: All UL listed valves include type 2509 1/2" conduit cable plug

DTS 1000082431 EN Version: - Status: RL (released | freigegeben | validé) printed: 13.08.2008

Type 2509 Dimensions [mm]

