

2/2-way Diaphragm Valve with plastic body, pneumatically operated, 1/2" – 4"

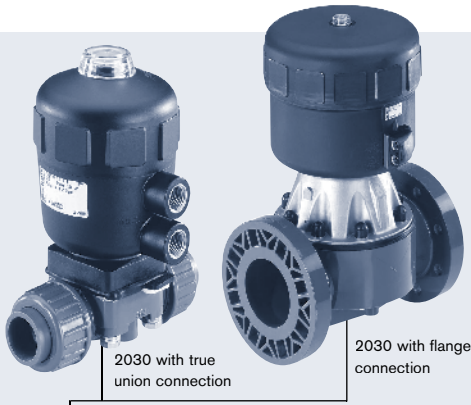

- Applications with aggressive media
- Flow-optimised body with zero dead volume
- Self-draining installation possible
- Removable radial true union, spigot and flange connections

Type 2030 can be combined with...

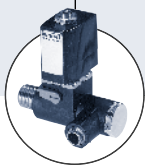

Type 6012/6014 P

Pilot valve



Type 8631

TopControl On/Off

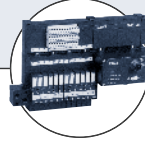

Type 8640/8644

Valve bank

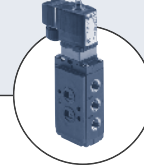

Type 6519 NAMUR

Solenoid valve

Pilot controlled diaphragm valve with piston actuator and diaphragm seal.
As standard, actuator from PA.
The flow optimised and zero dead volume valve body makes high flow rates possible.

Installation for self-draining

$\alpha = 15$ to 30°

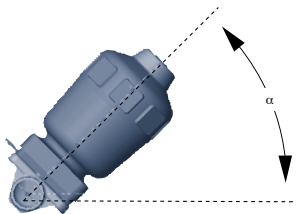

Technical data	
Orifice	1/4" – 4"
Body materials	PVC-U, PP, PVDF
Actuator material	PA polyamide (PPS on request)
Seal material	EPDM, PTFE/EPDM
Media	Neutral gases and liquids, aggressive or abrasive media
Viscosity	No limit
Media temperature	See charts on pg. 2
Ambient temperature	14°F to 140°F (-10 °C to 60°C) (PA) Actuator size ≥ 175 mm: 14 to 122 °F (-10 to 50 °C)
Control medium	Neutral gases, air
Port connections	DN 15-50: True union and spigot connections DN 65-100: Fixed flanges
Installation	As required, preferably with actuator in upright position

Media temperature

Pressure-temperature compatibility charts

1/2" – 2"

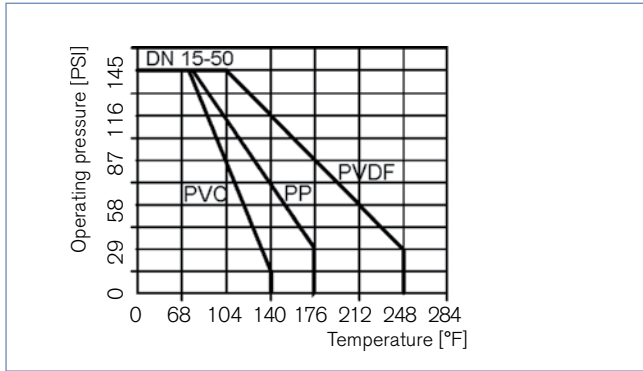

2 1/2" – 4"

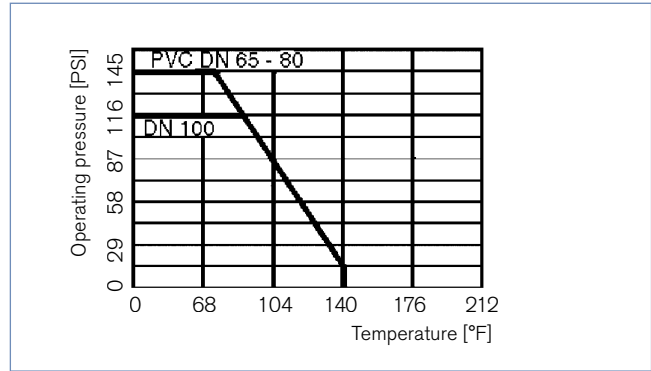

Important for the material selection!

Note that the permissible operating pressure is dependent on the media temperature.

Materials

1/2" – 2"

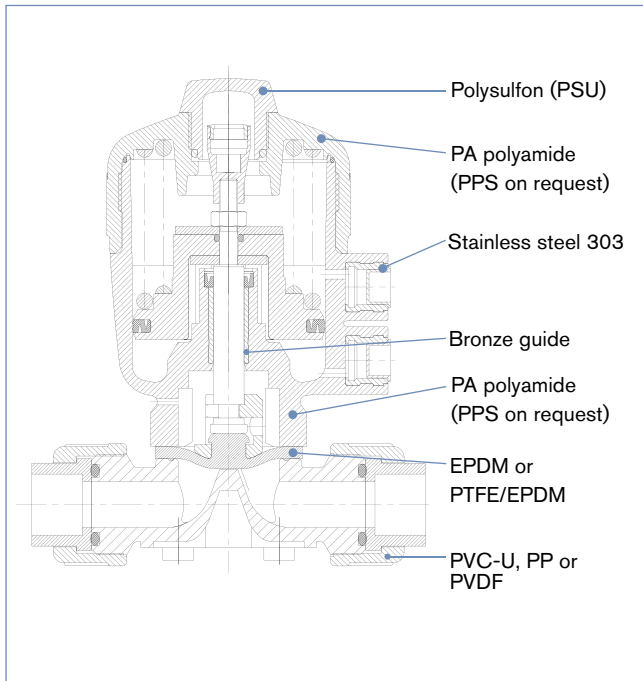

2 1/2" – 4"

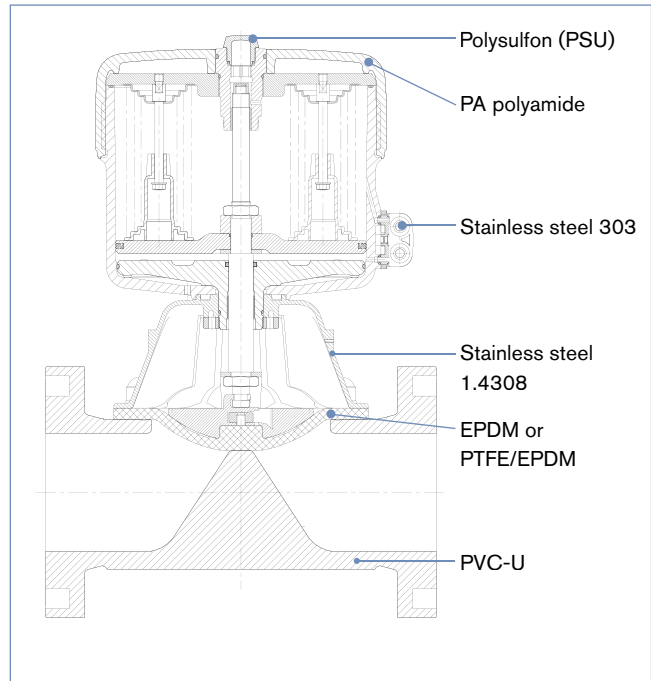

Approvals

Suitable for foodstuffs



The composition of the EPDM and PTFE/EPDM diaphragms corresponds to the *Code of Federal Regulations*, published by the *FDA* (Food and Drug Administration, USA).

The EPDM diaphragms correspond to the *KTW Recommendation* (Plastics in the Drinking Water Sector). A Manufacturer's Declaration will be supplied on request.

Ordering chart for diaphragm valves with piston actuator (other versions on request)

Body in PVC-U with true union or spigot connections; 1/2" - 2"



Control function	Orifice [mm]	Port connection [in]	Actuator size Ø [mm]	C _v value	Minimum pilot pressure [PSI]	Operating pressure [PSI]	Item no. true union
Seal material EPDM							
A 2/2-way, NC by spring action	15	1/2"	63	4.1	72.5	150	US03001
	20	3/4"	63	8.1	80.0	150	US05386
	25	1"	80	12.8	80.0	150	US03003
	32	1 1/4"	100	20.9	80.0	150	US03004
	40	1 1/2"	100	27.8	80.0	94.2	US06547
			125	30.2	80.0	150	US03005
50	2"	125	49.9	80.0	116	162 019	
B 2/2-way, NO by spring action	15	1/2"	63	4.1	see chart 1 on pg. 4	150	US03007
	20	3/4"	63	8.1	see chart 2 on pg. 4	150	--
	25	1"	80	12.8	see chart 2 on pg. 4	150	US3009
	32	1 1/4"	100	20.9	see chart 2 on pg. 4	150	--
	40	1 1/2"	125	27.8	see chart 2 on pg. 4	150	US03011
	50	2"	125	49.9	see chart 2 on pg. 4	150	US06378
Seal material PTFE/EPDM							
A 2/2-way, NC by spring action	15	1/2"	63	4.1	72.5	150	US03013
	20	3/4"	80	8.1	72.5	150	US03014
	25	1"	80	12.8	80.0	108.7	165 161
	32	1 1/4"	100	20.9	80.0	116	US03016
	40	1 1/2"	100	27.8	80.0	87.0	--
			125	30.2	80.0	150	US03017
50	2"	125	49.9	80.0	101.5	US03018	
B 2/2-way, NO by spring action	15	1/2"	63	4.1	see chart 3 on pg. 4	150	US03019
	20	3/4"	80	8.1	see chart 3 on pg. 4	150	US03020
	25	1"	80	12.8	see chart 3 on pg. 4	150	US03021
	32	1 1/4"	100	20.9	see chart 4 on pg. 4	150	--
	40	1 1/2"	125	30.2	see chart 4 on pg. 4	150	--
	50	2"	125	49.9	see chart 4 on pg. 4	150	US03024

Body in PVC-U with flange connection; 2 1/2" - 4"



Control function	Orifice [mm]	Port connection	Actuator size Ø [mm]	C _v value	Minimum pilot pressure [PSI]	Operating pressure [PSI]	Item no. flanges
Seal material EPDM							
A 2/2-way, NC by spring action	65	Fixed flanges	125	63.8	80.0	101.5	--
			175	69.6	65.0	150	--
	80	Fixed flanges	175	116	72.5	72.5	147 840
			225	116	72.5	150	147 842
100	Fixed flanges	225	185.6	72.5	116	--	
Seal material PTFE/EPDM							
A 2/2-way, NC by spring action	65	Fixed flanges	125	63.8	80.0	65.0	--
			175	69.6	65.0	116	--
	80	Fixed flanges	175	116	72.5	65.0	147 847
			225	116	72.5	150	147 849
100	Fixed flanges	225	185.6	72.5	58.0	--	

DTS 1000082416 EN Version: - Status: RL (released | freigegeben | validé) printed: 13.08.2008

Ordering chart for diaphragm valves with piston actuator (other versions on request)

Body in PVDF with spigot connections

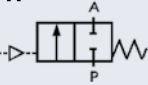
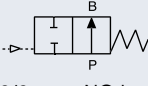
Control function	Orifice [mm]	Port connection [mm]	Actuator size Ø [mm]	C _v value	Minimum pilot pressure [PSI]	Operating pressure [PSI]	Item no. spigot
Seal material PTFE/EPDM							
A  2/2-way, NC by spring action	15	20	50	3.5	72.5	72.5	144 296
			63	4.1	72.5	150	141 453
	20	25	63	8.1	80	72.5	144 300
			80	8.1	72.5	150	141 463
	25	32	80	12.8	80	108.7	141 470
			100	20.9	80	116	141 476
	40	50	100	27.8	80	87	144 337
125			30.2	80	150	141 485	
50	63	125	49.9	80	101.5	141 491	
B  2/2-way, NO by spring action	15	20	63	4.1	see chart 3	150	141 501
			80	8.1	150	141 512	
	25	32	80	12.8	150	141 519	
			100	20.9	see chart 4	150	141 525
	40	50	125	27.8	150	141 534	
			125	49.9	150	141 540	



Pilot pressure charts for control function B

Seal material EPDM

Chart 1 - orifice 1/2"-1"

(Actuator size):
Orifice:

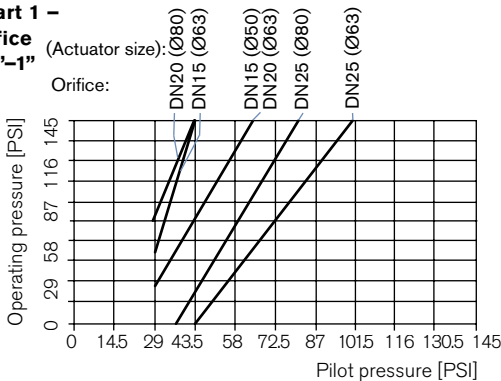
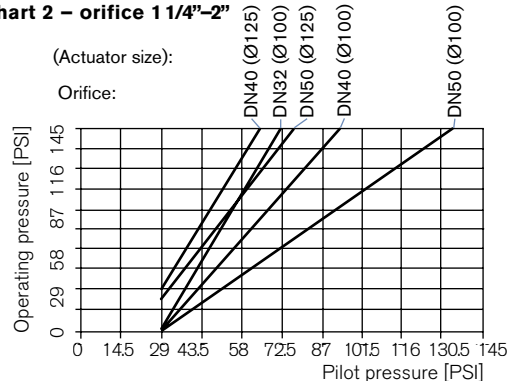

Chart 2 - orifice 1 1/4"-2"

(Actuator size):
Orifice:



Seal material PTFE/EPDM

Chart 3 - orifice 1/2"-1"

(Actuator size):
Orifice:

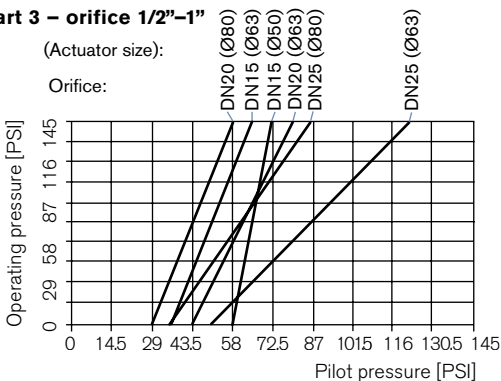
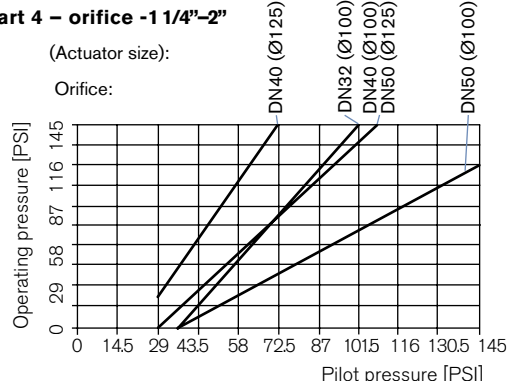

Chart 4 - orifice 1 1/4"-2"

(Actuator size):
Orifice:



DTS 1000082416 EN Version: - Status: RL (released | freigegeben | validé) printed: 13.08.2008

Ordering chart for accessories

Pilot valve according to actuator size	Voltage	Item no.
3/2-way pilot valves Type 6012 P/6014 P with banjo mounting, 1/4" NPT		
Type 6012 P for actuator Ø 40 mm	024 V/DC	427 923
	120 VAC/60 Hz	428 551
Type 6012 P for actuator Ø 50 and 63 mm	024 V/DC	428 565
	120 VAC/60 Hz	428 567
Type 6014 P for actuator Ø 80 to 125 mm 80.0	024 V/DC	429 134
	120 VAC/60 Hz	429 136
Type 6014 for actuator Ø 175 and 225 mm	024 V/DC	TBA
Type 6014 for actuator Ø 175 and 225 mm	120 VAC/60 Hz	TBA

Cable plug Type 2506 Form C or Type 2508 Form A

(other versions, please see datasheets for Types 2506/2508)

Plug configuration acc. DIN EN 175301-803 (previously DIN 43650)	Item no.
Form C, 0 to 250 V w/o circuit (f. Type 6012 P)	008 353
Form A, 0 to 250 V w/o circuit (f. Type 6014 P)	008 376

Options and accessories (on request)

- Control function I (double-acting actuator)
- Electrical position feedback, Type 1060, 1062 and 8631
- Magnetic-inductive proximity sensors, Type 1071
- Stroke limitation max. and min./max.
- Manual override (spring close valve only)
- Namur adapter for pilot valves

G x NPT or G x tube adapters			
Fitting type	Shape	Material	Item no.
Male G 1/8 x F 1/8 NPT	Straight	Nickel plated brass	US61425
Male G 1/8 x 1/4" tube	Straight	Nickel plated brass	US61579
Male G 1/8 x 1/4" tube	Swivel elbow	Nickel plated brass	US61440
Male G 1/4 x 1/4" tube	Straight	Nickel plated brass	US63250
Male G 1/4 x 1/4" tube	Swivel elbow	Nickel plated brass	US63251
Male G 1/4 x F 1/4" NPT	Straight	Nickel plated brass	US62754
Male G 1/4 x F 1/4" NPT	Straight	Stainless steel	US-1053

Silencers			
1/8	Straight tube	Polyethylene	CD03892
1/4	Straight tube	Polyethylene	CD01821
G 1/8" Silencer	Straight cone	Sintered bronze	005 305 D
G 1/4" Silencer	Straight cone	Sintered bronze	005 569 D
G 1/4" Silencer	Flat hex	Sintered bronze	780 811 Z

Note:

For design reasons, some of the accessories cannot be supplied for actuator sizes Ø 40, Ø 175 and Ø 225 mm. Please request the Accessories data sheet 2000-2031

Dimensions

1/2" – 2"

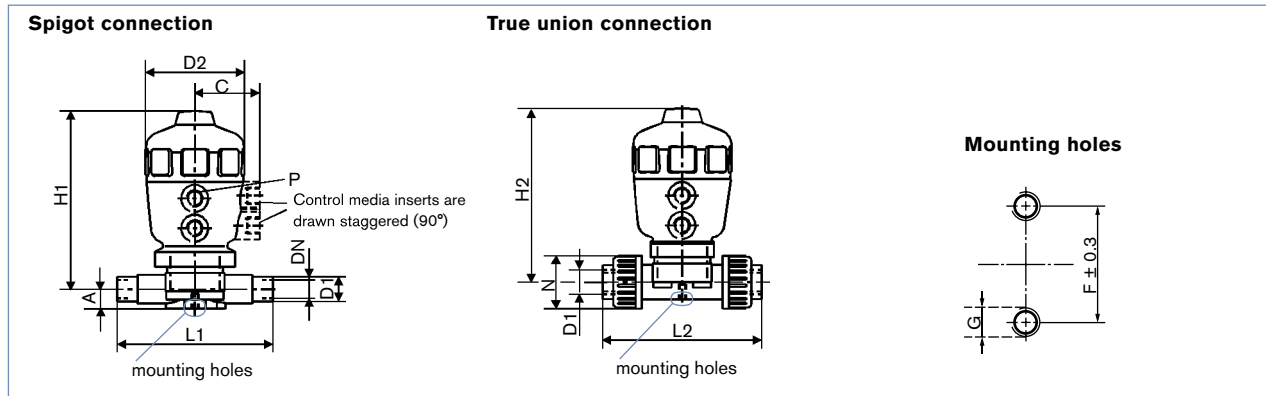

DN [mm]	All bodies							Spigot connection				True union connection			
	Actuator size Ø	C	D2	P	F	G	D1	A	H1	L1	D1	L2	H2	N	
15	50	1.5	2.5	G 1/8	1.0	M6	0.8	0.6	4.8	4.9	1/2"	5.0	4.8	1.7	
	63	2.0	3.1	G 1/4	1.0	M6	0.8	0.6	5.4	4.9	1/2"	5.0	5.5	1.7	
20	63	2.0	3.1	G 1/4	1.0	M6	0.9	0.7	5.7	5.7	3/4"	6.0	5.8	2.1	
	80	2.4	4.0	G 1/4	1.0	M6	0.9	0.7	6.8	5.7	3/4"	6.0	6.8	2.1	
25	80	2.4	4.0	G 1/4	1.0	M6	1.3	0.8	6.9	6.1	1"	6.5	6.9	2.4	
32	100	2.9	5.0	G 1/4	1.8	M8	1.6	1.0	9.0	6.9	1 1/4"	7.6	9.1	2.9	
40	100	2.9	5.0	G 1/4	1.8	M8	2.0	1.3	9.3	7.6	1 1/2"	8.7	9.4	3.3	
	125	3.4	6.0	G 1/4	1.8	M8	2.0	1.3	10.9	7.6	1 1/2"	8.7	10.9	3.3	
50	125	3.4	6.0	G 1/4	1.8	M8	2.5	1.5	11.1	8.8	2"	10.5	11.2	4.0	

2 1/2" – 4"

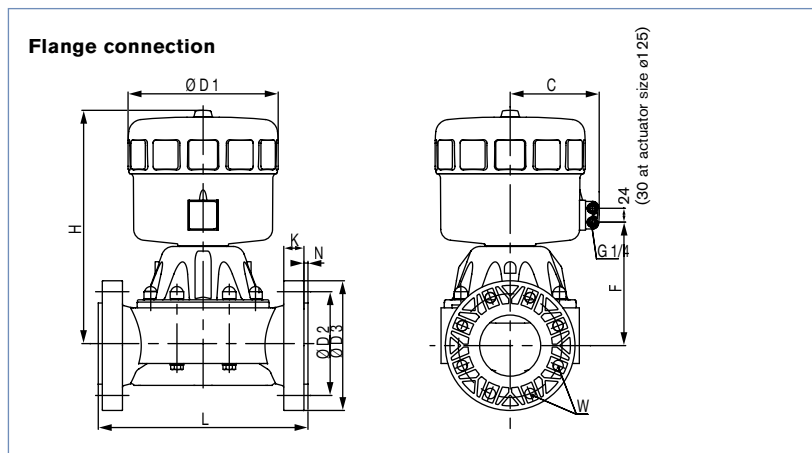

DN [mm]	Actuator size	Port connection	C	D1	D2	D3	F	H	K	L	W
65	125	Fixed flanges	3.4	6.2	5.5	7.3	5.0	11.6	1.1	11.4	4 x 90°
	175	Fixed flanges	5.1	8.3	5.5	7.3	7.1	15.2	1.1	11.4	4 x 90°
80	175	Fixed flanges	5.1	8.3	6.0	7.9	7.8	15.7	1.4	12.2	4 x 90°
	225	Fixed flanges	6.1	10.3	6.0	7.9	7.8	15.5	1.4	12.2	4 x 90°
100	225	Fixed flanges	6.1	10.3	7.5	8.9	8.3	16.1	1.4	13.8	8 x 45°

In case of special application conditions, please consult for advice.

We reserve the right to make technical changes without notice.

0602/3_US-en